

BINOCULARS & SPOTTING SCOPES. A TECHNICAL GUIDE.

UK



www.hawkeoptics.com
Born in the UK

A black and white photograph of a man with a beard, seen in profile from the chest up. He is wearing a dark jacket and looking through a large spotting scope mounted on a tripod. The background is a blurred landscape with hills and water. The text is overlaid on the right side of the image.

VISION ACCOMPLISHED

Hawke is at the forefront of optical performance with class-leading innovation and design.

Accuracy, strength and precision; our optics blend iconic design, exceptional engineering and unrivalled craftsmanship to create an unforgettable viewing experience.

The following guide offers further information to assist in the purchase of your new Hawke binoculars and spotting scopes.

CONTENTS

BINOCULAR SPECIFICATION & TERMINOLOGY – 04-05

Magnification
Objective Lens
Field of View (FOV)
Exit Pupil
Interpupillary Distance
Eye Relief
Close Focus

GLASS QUALITY & COATINGS – 06-07

Extra-low Dispersion (ED) Lenses
Fully Multi-Coated (FMC) Lens Coating
BAK-4 Roof Prism
Phase Corrected Coating
Silver Mirror Coating
Dielectric Coating
Water Repellent Coating
Strehl Ratio Tested

PARTS & MECHANICAL FEATURES – 08-09

Dioptre
Focus Wheel
Hinge Design
Tripod Attachment

Twist-Up Eye Cups
Strap Loops
Nitrogen Purged
Chassis

FOCUSING YOUR BINOCULAR – 10-11

Set-up

SPOTTING SCOPE SPECIFICATION & TERMINOLOGY – 12-13

Magnification
Objective Lens
Field of View (FOV)
Eye Relief
Close Focus
Exit Pupil

GLASS QUALITY & COATINGS – 14-15

Extra-low Dispersion (ED) Lenses
Fully Multi-Coated (FMC) Lens Coating
BAK-4 Porro Prism
Dielectric Coating

PARTS & MECHANICAL FEATURES – 16-17

Sunshade
Nitrogen Purged
Focus Wheel
Tripod Attachment
Eye Cup Adjustment
Digi-scoping
Fixed Power Eyepiece

STEP BY STEP GUIDE TO USING A DIGI-SCOPE – 18-19

Overview
Step by Step

SUPPLIED WITH – 20-21

Binoculars
Spotting Scope

ALSO AVAILABLE – 22

Binocular Harness Pro Pack
Binocular Harness Pack
Binocular Harness Strap

WARRANTY – 23

We've got you covered...
...for life

BINOCULAR SPECIFICATION & TERMINOLOGY

01 | Magnification

The binocular magnification specification is the first number in the binocular description. e.g. a 10x42 binocular has a magnification power of 10x. That is to say, the viewed image will be 10x larger than with the naked eye.

While a higher magnification will make the image larger and easier to view it will also reduce the field of view and make any movement of the binoculars more exaggerated.

Typically an 8 or 10x magnification power is the preferred choice, but 12x magnification is also available in some models.

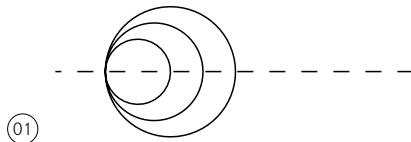

02 | Objective Lens

The objective lenses are at the front end of the binocular. The width of the objective lens relates to the second number in the binoculars description. e.g. a 10x42 binocular has a pair of objective lenses that each measure 42mm in diameter.

Larger objective lenses give better light transmission and allow for a brighter picture. A larger objective lens will allow the binoculars to be used in lower light conditions.

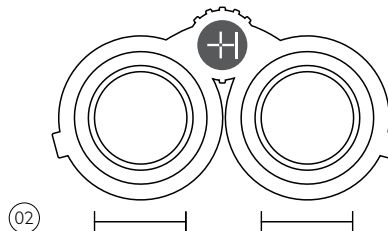

03 | Field of View (FOV)

The width of the binocular's view. A larger FOV allows for a wider image to be seen.

This can be measured in terms of angle (degrees), or by a set distance. e.g. the FOV of the Frontier ED X 8x42 is 142m wide when looking at an image 1000m away. This is equivalent to 426ft wide when looking at an image 1000yds away.

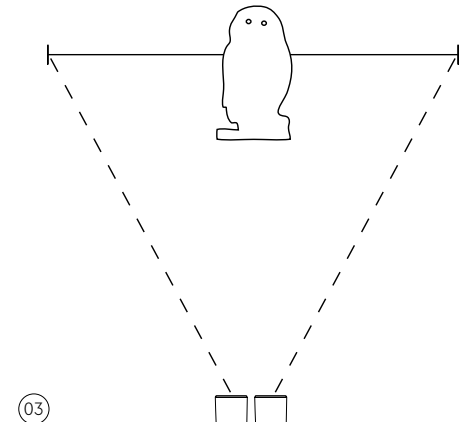

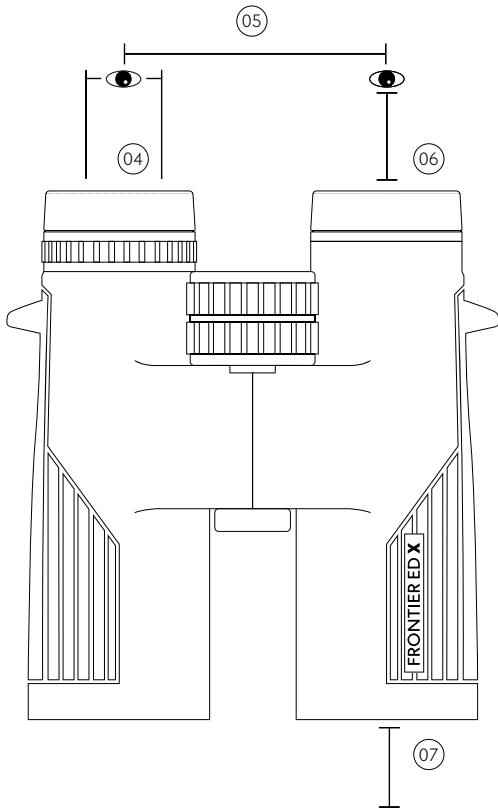

04 | Exit Pupil

The diameter of the viewing image when the eye is positioned at the correct eye relief. This is calculated by dividing the objective lens diameter by the binocular magnification. e.g. for a 10x42 binocular we divide the objective lens diameter of 42mm by the magnification power of 10 to get 4.2mm.

05 | Interpupillary Distance

The distance between the two ocular lenses. This is measured from the middle of one lens to the other. The interpupillary distance has a range, as the distance will change depending how open or closed the binoculars hinge is set.

06 | Eye Relief

The correct distance for the pupil to be located from the ocular lens. When at this distance the best viewing experience will be achieved. All Hawke binoculars are fitted with adjustable twist-up eye cups to help gain the correct eye relief distance and comfortable viewing experience. (see page 9)

07 | Close Focus

The closest possible distance that the binoculars can be focused at. Binoculars with an ability to focus at close range allow for better viewing of nearby objects such as insects.

GLASS QUALITY & COATINGS

01 | Extra-low Dispersion (ED) Lenses

ED lenses are the most effective way to improve image quality and stop colour fringing (chromatic aberration). ED glass allows for better concentration and direction of light wavelengths, which give a significantly sharper image and improved contrast of colours and light.

02 | Apochromatic (APO) Lenses

An APO lens is built from multiple elements to more tightly control multiple colour wavelengths into one. This further reduces chromatic aberration and enhances image quality.

03 | Fully Multi-Coated (FMC) Lens Coating

There are many lenses within a binoculars optical system. Hawke's FMC lenses ensure that both sides of every lens have multiple layers of coating which assist with light transmission and help produce brighter images with improved contrast.

04 | BAK-4 Roof Prism

BAK-4 is a type of glass used within the prism, which is a system of glass elements inside the binocular that ensure the viewed image is the correct orientation after being magnified. A roof prism is a more compact and sharper version of older traditional Porro prisms.

05 | Phase Corrected Coating

The light traveling through a binocular prism is reflected several times and as such can lose its "phase", meaning that colours can appear overlapping and produce colour fringing, also known as chromatic aberration. A phase correction coating helps to stop chromatic aberration.

06 | Silver Mirror Coating

A silver mirror coating can be applied to elements within the prism and increase reflection. This also improves brightness and colour reproduction. The silver coatings have a reflectivity of 95% to 98%.

07 | Dielectric Coating

Dielectric Coating of the prisms improves internal reflection even more than a silver mirror coating. This maximises the quality of visible light and produces clear, high-contrast images, similar to those seen by the naked eye.

08 | Water Repellent Coating

Water repellent coatings significantly improve optical performance in wet weather conditions. The extra lens coating encourages the water droplets to "bead" and form into smaller drops that are easier to clean and will more actively run off the glass lens.

09 | Strehl Ratio Tested

Meeting the Strehl Ratio optical parameter ensures the image is crisp with no, or less, haziness. This produces a feeling of not actually looking through lenses.



CONVENTIONAL GLASS

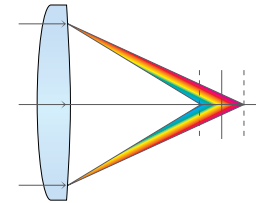

① ED GLASS

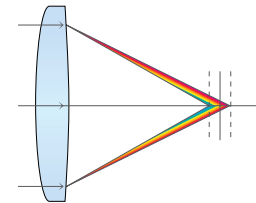

② APO LENS

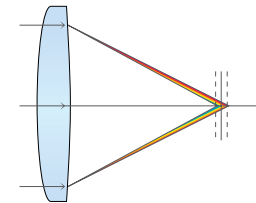



PARTS & MECHANICAL FEATURES

01 | Dioptre

Each binocular is equipped with an adjustable dioptre which is used to correct any imbalance in eye strength. Typically the dioptre adjuster is positioned on the right hand eyepiece.

02 | Focus Wheel

The focus wheel can be easily rotated to change the focal distance of the binoculars. All Hawke binoculars feature a central focus wheel which accurately guides and adjusts the internal lenses while keeping them protected from outside elements and dirt.

03 | Hinge Design

All Hawke models are adjustable at a central hinge.

04 | Tripod Attachment

All Hawke full-sized binoculars have a tripod fitting with a standard tripod thread (1/4-20 UNC). This allows for positioning and solid mounting to keep the binoculars still when in use

05 | Twist-Up Eye Cups.

With multiple height settings, the twist-up eye cups can be set to ensure the best eye relief for your use. Eyeglasses users often leave the twist-up eye cups in the downward position, while non-eyeglasses users rotate the twist-up mechanism upright. The Frontier models have the added feature of replaceable twist-up eye cups with position stops, allowing for the eye cups to be replaced easily.

06 | Strap Loops

All Hawke binoculars are engineered with a low-profile strap loop that provides a secure attachment point for your beloved optics.

07 | Nitrogen Purged

Hawke binoculars are filled with nitrogen gas to ensure that no condensation or humidity is held within the optical system which can otherwise haze and cloud the optical view when moving between warm and cold conditions. The nitrogen gas is sealed into the binoculars during manufacture to ensure no moisture can infringe the optics.

08 | Chassis

Designed from conception to offer the best performance available, models include lightweight magnesium alloy body or polycarbonate chassis and soft touch rubbers.

FOCUSING YOUR BINOCULAR

Set-up

Set the dioptre adjuster (01) to the centre position.

Close your right eye and rotate the focusing wheel (02) until the image in the left eyepiece appears sharp.

Now close your left eye and rotate the dioptre adjuster (01) until the image is sharp.

The binoculars have now been adjusted to your eyes.

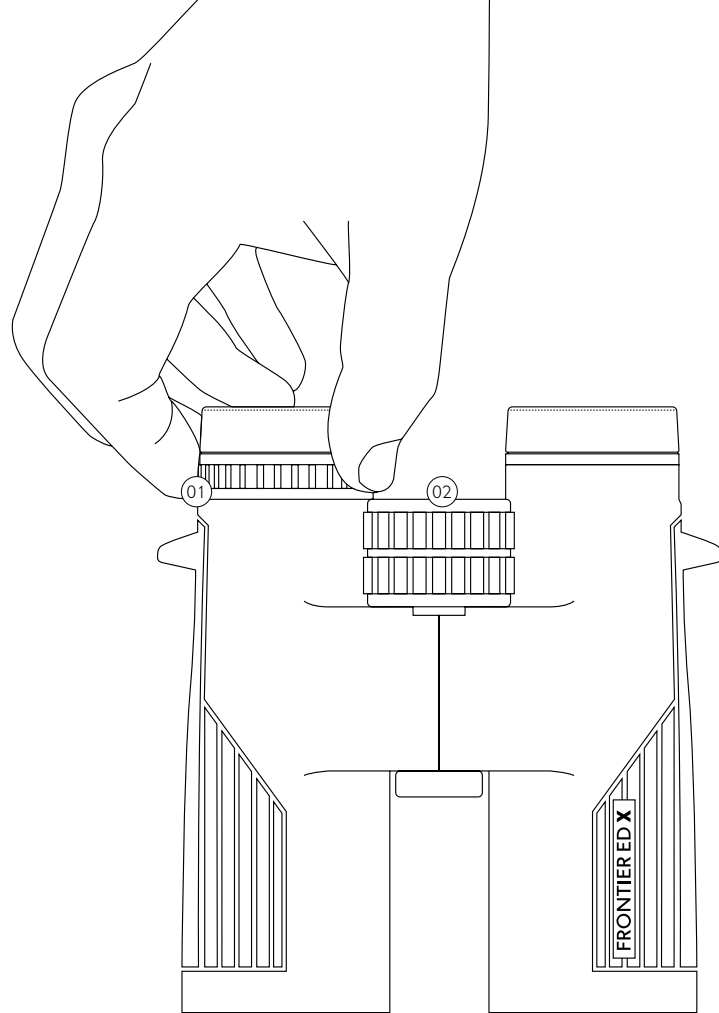



SPOTTING SCOPE SPECIFICATION & TERMINOLOGY

01 | Magnification

Spotting scope magnifications are often variable as the zoom eyepiece allows the user to change from low to high magnification. The magnification range is denoted by the first two numbers in the spotting scope's description. e.g. a 20-60x85 spotting scope has a magnification power of 20 to 60x. That's to say the viewed image will be 20 to 60x larger than with the naked eye, depending on the magnification setting.

Whilst a higher magnification will make the image larger and easier to view it will also reduce the field of view and make any movement and tracking of animals more difficult.

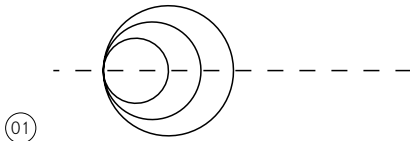

02 | Objective Lens

The objective lens is the front lens of the spotting scope. The width of the objective lens relates to the last number in the spotting scope's description. e.g. a 20-60x85 spotting scope has an objective lens that measures 85mm in diameter.

Larger objective lenses give better light transmission and allow for a brighter picture. A larger objective lens will allow the spotting scope to be used in lower light conditions.

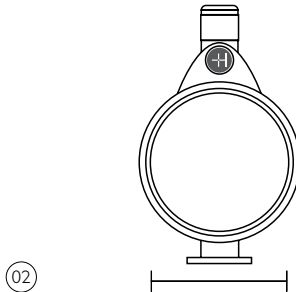

03 | Field of View (FOV)

The width of the spotting scope's view. A larger FOV allows for a wider image to be seen.

This can be measured in terms of angle (degrees), or by a set distance. e.g. the FOV of a 20-60x85 spotting scope could be 35 – 17.5m wide when looking at an image 1000m away. The view is 35m wide when on the lowest 20x magnification and is 17.5m wide when on the highest 60x magnification. This is also equivalent to 105 – 52.5ft wide when looking at an image 1000yds away.

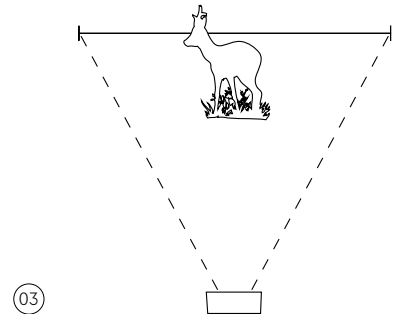

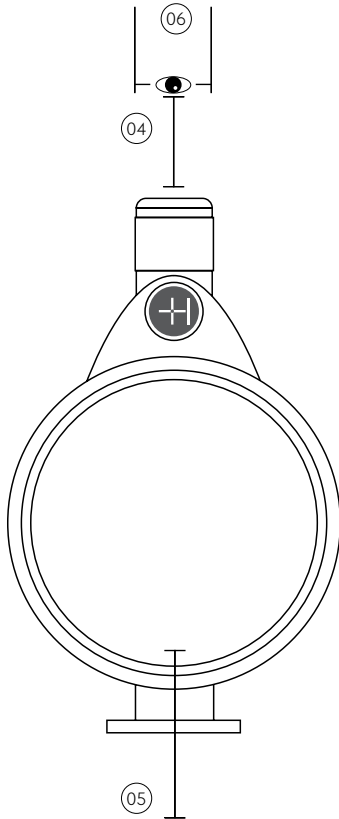

04 | Eye Relief

The distance from the pupil to the ocular lens. When at the correct distance the best viewing experience will be achieved. Some Hawke spotting scopes are fitted with an adjustable twist-up eye cup to help gain the correct eye relief distance and comfortable viewing experience.

05 | Close Focus

The closest possible distance that the spotting scope can be focused at. Spotting scopes with an ability to focus at a nearer range allow for better viewing of nearby objects such as insects.

06 | Exit Pupil

The diameter of the viewing image when the eye is positioned at the correct eye relief.

GLASS QUALITY & COATINGS

01 | Extra-low Dispersion (ED) Lenses

ED lenses are the most effective way to improve image quality and stop colour fringing (chromatic aberration). ED glass allows for better concentration and direction of light wavelengths, which give a significantly sharper image and improved contrast of colours and light.

02 | Fully Multi-Coated (FMC) Lens Coating

There are many lenses within an optical system. Hawke's FMC lenses ensure that both sides of every lens have multiple layers of coating which assist with light transmission and help produce brighter images with improved contrast.

03 | BAK-4 Porro Prism

A prism is a system of glass elements inside the spotting scope that ensure the viewed image is the correct orientation after being magnified. BAK-4 glass ensures excellent light refraction properties and is superior to BK-7 glass.

04 | Dielectric Coating

Dielectric Coating of the prisms improves internal reflection even more than a silver mirror coating. This maximizes the quality of visible light and produces clear, high-contrast images, similar to those seen by the naked eye.

CONVENTIONAL GLASS

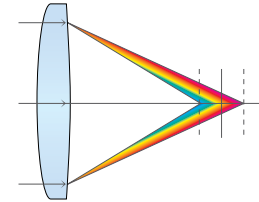

01 ED GLASS

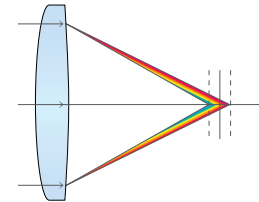

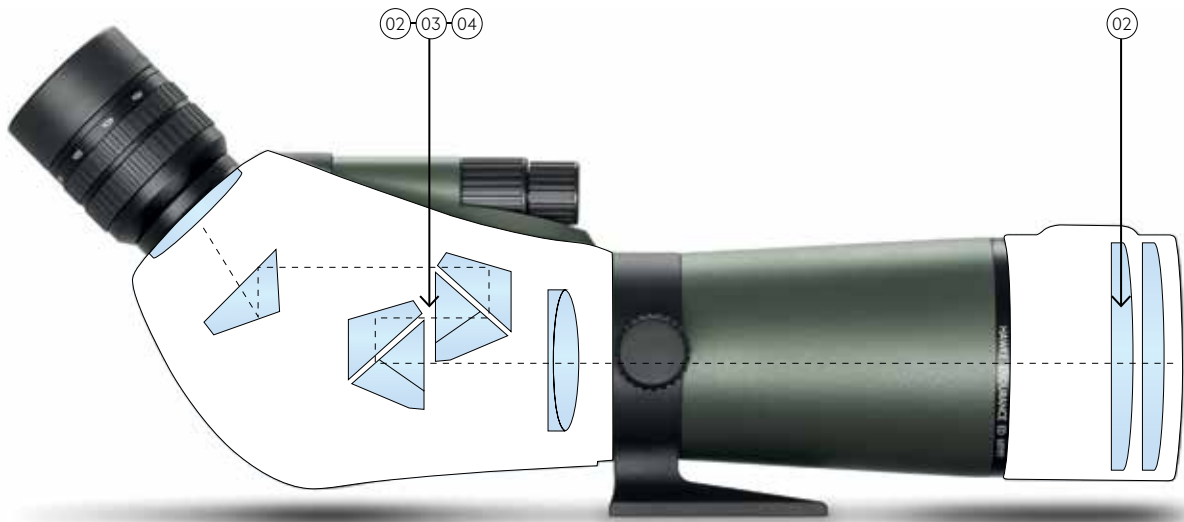



PARTS & MECHANICAL FEATURES

01 | Sunshade

When using the scope in bright conditions, or when the sun is low and shining into the spotting scope's lens, the built-in extendable sunshade can be used to prevent glare.

02 | Nitrogen Purged

Hawke spotting scopes are filled with nitrogen gas to ensure that no condensation or humidity is held within the optical system which can otherwise haze and cloud the optical view when moving between warm and cold conditions. The nitrogen gas is sealed into the spotting scope during manufacture to ensure no moisture can infringe the optics.

03 | Focus Wheel

The focus wheel can be easily rotated to change the focal distance of the spotting scope. All Hawke spotting scopes are designed to accurately guide and adjust the internal lenses while keeping them protected from outside elements and dirt.

- Dual Focus Knob – a dual Focus Knob has two sensitivities for adjustment; coarse and fine. The coarse adjustment is fast changing for quick settings, then the fine adjustment allows for more accurate and precise focus correction.
- Focus Knob – a single Focus Knob that allows for adjustment from near to far focal distance.

04 | Tripod Attachment

All Hawke spotting scopes have a tripod fitting with a standard tripod thread (1/4-20 UNC). This allows for positioning and solid mounting to keep the spotting scope still when in use. A rotating tripod band is available on some models to allow body rotation and alternative scope orientation.

05 | Eye Cup Adjustment

The eye cup can be set to ensure the best eye relief for your use. Eyeglasses users often leave the eye cup adjustment in the downward position, while non-eyeglasses users keep the eye cup upright.

- Twist-Up – with 3 levels of adjustment the eye cup can be twisted into position to suit.
- Folding – the rubber eye cup can be folded down to suit eyeglasses wearers.

06 | Digi-scoping

Digi-scoping is the art of using the spotting scope's optical performance to enhance your camera and capture photos at a much higher magnification. Digi-scope adaptors are available to attach a camera to the spotting scope.

A DIGI-SCOPE GUIDE

Overview

Spotting scopes can be used in conjunction with digital cameras to obtain close up photos. Hawke offers a range of precision engineered accessories that assist with the setup. Converting the Hawke range of spotting scopes to a digi-scope has never been easier.

Simply choose the digi-scope adaptor for your spotting scope and select the T2 adaptor relevant to your camera.

01 | Spotting Scope

02 | Digi-Scope Adaptor

03 | SLR T2 Camera Adaptor

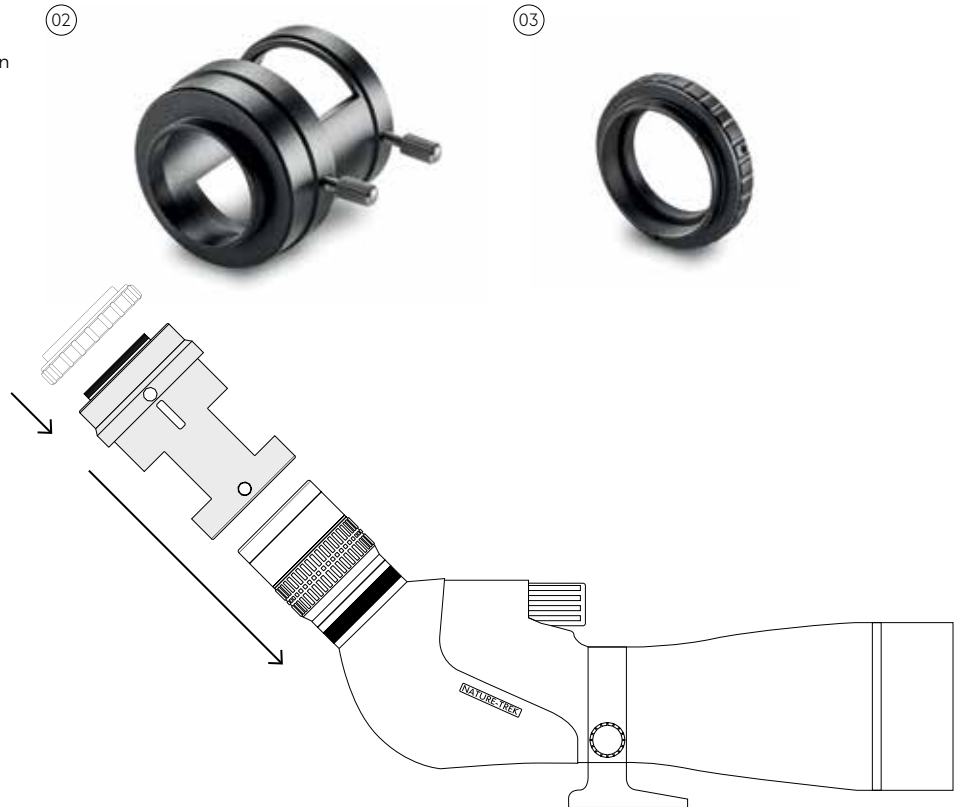



HAWKE

Canon

EOS

02

03

01

ENDURANCE ED

SUPPLIED WITH

Binoculars

All binocular models are supplied with:

01 | Box

02 | Instruction Manual

03 | Lens Cloth

04 | Protective Carry Case

05 | Carry Case Strap

06 | Neck Strap

07 | Objective Lens Covers

08 | Ocular Lens Covers

01



02



03



04



05



06



07



08



Please note styles can vary from range to range

Spotting Scopes

All Spotting Scope models are supplied with:

01 | Box

02 | Instruction Manual

03 | Lens Cloth

04 | Stay-On Cover

05 | Carry Strap

06 | Stay-On Objective Lens Cover

07 | Ocular Lens Cover

08 | Eyepiece Lens Covers

09 | Protective Hard Carry Case
(Vantage models only)

10 | Mini Tripod
(Vantage models only)

01



02



03



04



05



06



07



08



09



10



Please note styles can vary from range to range

ALSO AVAILABLE

Further protection

Protecting your binoculars.

01 | Binocular Harness Pro Pack (99 400)

02 | Binocular Harness Pack (99 401)

03 | Binocular Harness Strap (99 402)

01



02



03



HAWKE NO-FAULT LIFETIME WARRANTY

We've got you covered...
...for life

When you buy your new Hawke scope or binocular, you're buying peace of mind... for life. In the event your product becomes damaged or defective we'll repair it at no charge to you. It doesn't matter how it happened or whose fault it was - we've got you covered. The Hawke No-Fault Lifetime Warranty is only available directly through our UK service centre and not through your retailer.

To request service, please follow links to service procedure at: www.hawkeoptics.com

The Hawke No-Fault Lifetime Warranty applies to spotting scopes, binoculars and monoculars only. Other accessories are covered by our two year warranty. The Hawke No-Fault Lifetime Warranty does not cover loss, theft, deliberate damage or cosmetic damage that does not hinder the performance of the product. Occasionally we may replace your product with an equivalent of equal or better physical condition. Applies to the original owner only. Hawke's No-Fault Lifetime Warranty applies only to products purchased after January, 1 2018. Items purchased prior to January 1, 2018 are covered under Hawke's original warranty, see your instruction booklet for details.

You can register your purchase at www.hawkeoptics.com



UNITED KINGDOM

Avocet House, Wilford Bridge Road,
Melton, Woodbridge, Suffolk IP12 1RB, UK

t: 0345 345 5555

e: uk@hawkeoptics.com



www.hawkeoptics.com
 Born in the UK