

INSTRUCTION MANUAL

Orion[®] SkyView™ Pro 8 EQ

#9738 Equatorial Reflecting Telescope



 **ORION[®]**
TELESCOPES & BINOCULARS
Providing Exceptional Consumer Optical Products Since 1975

Customer Support (800)-676-1343
E-mail: support@telescope.com
Corporate Offices (831)-763-7000
89 Hangar Way, Watsonville, CA 95076
OrionTelescopes.com



Figure 1. The SkyView Pro 8 EQ.

Welcome to the exciting world of amateur astronomy! Your new SkyView Pro 8 EQ is designed for high-resolution viewing of astronomical objects. With its precision optics and equatorial mount, you'll be able to locate and enjoy hundreds of fascinating celestial denizens, including the planets, Moon, and a variety of deep-sky galaxies, nebulas, and star clusters.

These instructions will help you set up, properly use, and care for your telescope. Please read them thoroughly before getting started.

Table of Contents

1. Unpacking	3
2. Parts list	3
3. Assembly	3
4. Balancing the Telescope	5
5. Using Your Telescope	6
6. Setting Up and Using the Equatorial Mount.	7
7. Collimation (Aligning the Mirrors)	11
8. Astronomical Observing	14
9. Astrophotography	17
10. Care and maintenance	18
11. Specifications	19

1. Unpacking

The entire mount will arrive in two boxes, one containing the mount and tripod, the other containing the optical tube. Be careful unpacking the boxes. We recommend keeping the boxes and all original packaging. In the event that the telescope needs to be shipped to another location, or returned to Orion for warranty repair, having the proper boxes and packaging will help ensure that your mount will survive the journey intact.

Make sure all the parts in the Parts List are present. Be sure to check each box carefully, as some parts are small. If anything appears to be missing or broken, immediately call Orion Customer Support (800-676-1343) or email support@telescope.com for assistance.

WARNING: *Never look directly at the Sun through your telescope or its finder scope—even for an instant—without a professionally made solar filter that completely covers the front of the instrument, or permanent eye damage could result. Young children should use this telescope only with adult supervision.*

2. Parts List

The box containing the mount will have the following parts:

- 1 Tripod
- 1 Equatorial mount
- 1 Tripod support tray
- 1 Tube ring mounting plate
- 1 Counterweight shaft
- 1 Latitude adjustment L-bolt
- 2 Counterweights
- 2 Slow-motion control knobs
- 1 R.A. axis rear cover

The box containing the optical tube will have the following parts:

- 1 Optical tube assembly
- 2 Tube rings with mounting screws
- 1 25mm Sirius Plössl eyepiece
- 1 10mm Sirius Plössl eyepiece
- 1 Finder scope
- 1 Finder scope bracket with O-ring
- 1 Collimation cap
- 1 Camera adapter
- 1 Dust cover

3. Assembly

1. Stand the tripod legs upright and spread the legs out as far as they will go. Keep the tripod legs at their shortest (fully retracted) length, for now; you can extend them to a more desirable length later, after the scope is fully assembled.
2. Place the base of the equatorial mount into the tripod head. Orient the equatorial mount so that the post on the tripod head lines up with the azimuth adjustment knobs on the equatorial mount (Figure 2). You may need to loosen the azimuth adjustment knobs on the equatorial mount in order to fit the mount into the tripod head.
3. Thread the central support shaft into the equatorial mount until tight. This will secure the equatorial mount to the tripod head.
4. Remove the knob and washer from the bottom of the center support shaft. Slide the tripod support tray up the bottom

of the central support shaft until the three tray arms are touching the legs of the tripod. The flat side of the accessory tray should be facing up. Make sure the “V” of each tray arm is against a tripod leg. Place the washer back on the center support shaft against the tray, and thread the securing knob all the way up the center support shaft until it is tight against the tray. The tripod support tray provides additional stability for the tripod, and holds five 1.25" eyepieces and two 2" eyepieces.

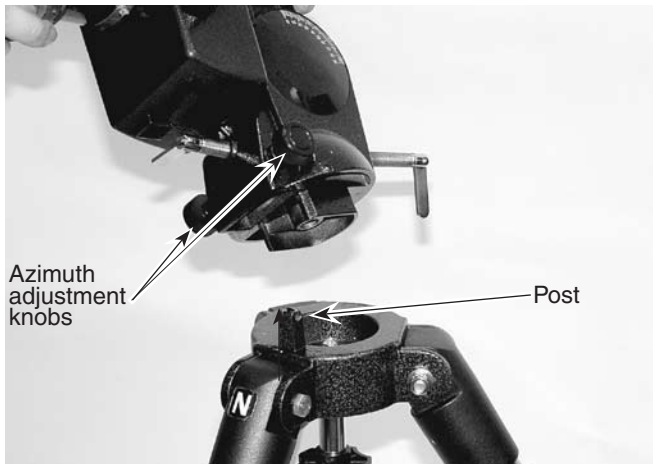

Figure 2. Orient the equatorial mount so that the post on the tripod head lines up with the azimuth adjustment knobs on the equatorial mount.

5. Thread the Latitude adjustment L-bolt into the rear of the of the equatorial mount casing as shown in place in Figure 1.
6. Thread the counterweight shaft into the equatorial mount at the base of the declination axis until tight. Make sure the casting at the top is threaded clockwise as far as it will go before attaching the shaft. Once the shaft is installed, turn the casting counter-clockwise until the top of the casting is flush with the mount.
7. Remove the knurled “toe saver” retaining screw on the bottom of the counterweight shaft and slide both counterweights onto the shaft. Make sure the counterweight lock knobs are adequately loosened to allow the counterweight shaft to pass through the hole. Position the counterweights about halfway up the shaft and tighten the lock knobs. Replace the toe saver at the end of the bar. The toe saver prevents the counterweights from falling on your foot if the lock knobs happen to come loose.
8. Attach the slow-motion control knobs to the right ascension and declination gear shafts of the equatorial mount by sliding them onto the shaft. Line up the flat on the end of the gear shaft with the corresponding feature in the interior of the knob to attach them properly. The knobs can be attached to either end of the shafts; use whichever end is most convenient.
9. Attach the tube mounting rings to the tube mounting plate using the attachment screws that are on the tube rings. The screws should go through the holes on the outer ends

of the mounting plate and rethread into the tube rings. Note that the side of the mounting plate with the central “groove” will be facing up. Use the small wrench to secure the tube rings to the mounting plate.

10. Loosen the black mounting plate securing knob as well as the metal safety thumbscrew. Place the mounting plate in the dovetail slot on top of the equatorial mount. Position the mounting plate so that it is centered on the dovetail slot. Re-tighten the mounting plate securing knob until the mounting plate is secure. Then, tighten the safety thumbscrew. The safety thumbscrew will ensure that the mounting plate (and telescope tube) will not fall off the EQ mount if the mounting plate securing knob should come loose.
11. Open the tube rings and lay the telescope optical tube in the rings at about the midpoint of the tube’s length. Rotate the tube so that the focuser is at a convenient height for viewing. Close the tube rings and tighten them.

Installing the Finder Scope

To place the finder scope (Figure 3a) in the finder scope bracket, unthread the two black nylon thumbscrews until the screw ends are flush with the inside diameter of the bracket. Place the O-ring that comes on the base of the bracket over the body of the finder scope until it seats into the slot on the middle of the finder scope. Slide the eyepiece end (narrow end) of the finder scope into the end of the bracket’s cylinder opposite the alignment thumbscrews while pulling the chrome, spring-loaded tensioner on the bracket with your fingers (Figure 3b). Push the finder scope through the bracket until the O-ring seats just inside the front opening of the bracket cylinder. Release the tensioner and tighten the two alignment thumbscrews a couple of turns each to secure the finder scope in place. Insert the base of the finder scope bracket into the dovetail holder on the top of the focuser. Lock the bracket into position by tightening the knurled thumbscrew on the dovetail holder.

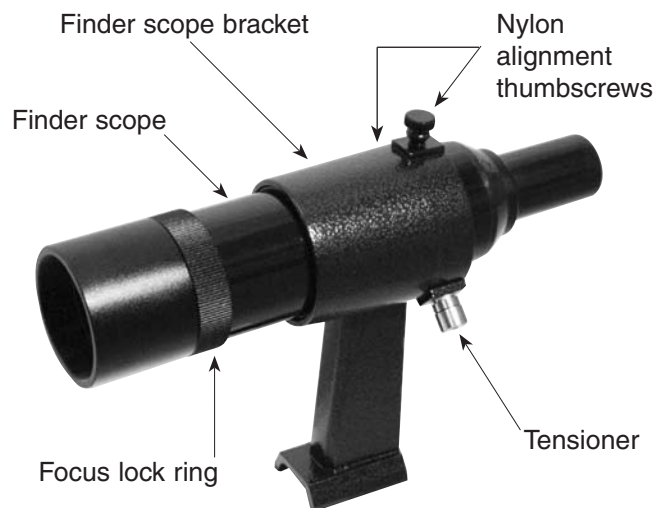

Figure 3a. The 8x40 finder scope.



Figure 3b. Pull-back on the tensioner and slide the finder scope into its bracket until the O-ring is seated in the bracket ring.

Inserting the Eyepiece

Loosen the thumbscrew on the 1.25" adapter (Figure 4) and remove the small dust cap. Insert the 25mm eyepiece into the focuser and secure it with the thumbscrew.

Your telescope is now completely assembled and should appear as shown in Figure 1.

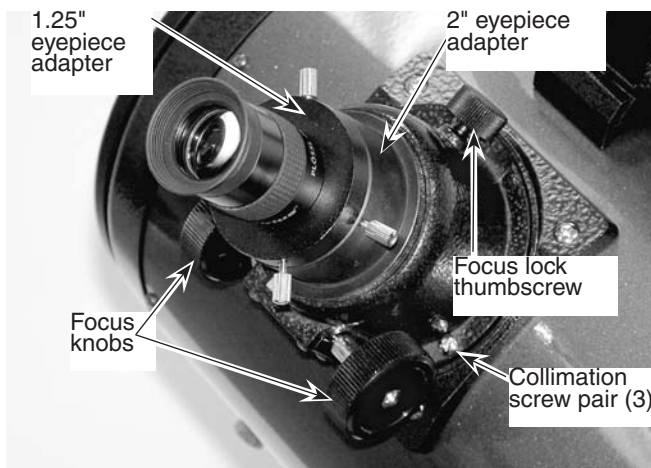

Figure 4. The 2" focuser of the SkyView Pro 8 EQ.

4. Balancing the Telescope

To ensure smooth movement of the telescope on both axes of the equatorial mount, it is imperative that the optical tube is properly balanced. We will first balance the telescope with respect to the right ascension (R.A.) axis, then the declination (Dec.) axis.

1. Keeping one hand on the telescope optical tube, loosen the R.A. lock lever. Make sure the Dec. lock lever is locked, for now. The telescope should now be able to rotate freely about the right ascension axis. Rotate it until the counterweight shaft is parallel to the ground (i.e., horizontal).
2. Now loosen both counterweight lock knobs and slide the weights along the shaft until they exactly counterbalance the telescope (Figure 5a). That's the point at which the shaft remains horizontal even when you let go with both hands (Figure 5b).
3. Retighten the counterweight lock knobs. The telescope is now balanced on the right ascension axis.
4. To balance the telescope on the declination axis, first tighten the R.A. lock lever, with the counterweight shaft still in the horizontal position.
5. With one hand on the telescope optical tube, loosen the Dec. lock lever. The telescope should now be able to rotate freely about the Dec. axis. Loosen the tube ring clamps a few turns, until you can slide the telescope tube forward and back inside the rings. (this can be aided by using a slight twisting motion on the optical tube while you push or pull on it). (Figure 5c).
6. Position the telescope in the mounting rings so it remains horizontal when you carefully let go with both hands. This is the balance point for the optical tube with respect to the Dec. axis. (Figure 5d)
7. Retighten the tube ring clamps.

The telescope is now balanced on both axes. When you loosen the lock lever on one or both axes and manually point the telescope, it should move without resistance and should not drift from where you point it.



5. Using Your Telescope

Focusing the Telescope

With the 25mm eyepiece inserted in the focuser, move the telescope so the front (open) end is pointing in the general direction of an object at least 1/4-mile away. Now, with your fingers, slowly rotate one of the focusing knobs until the object comes into sharp focus. Go a little bit beyond sharp focus until the image just starts to blur again, then reverse the rotation of the knob, just to make sure you've hit the exact focus point.

NOTE: The image in the telescope will appear rotated 180° (upside down and reversed left-to-right). This is normal for astronomical scopes. The finder scope view will also be rotated 180°. (see Figure 6)



View through finder scope and telescope

Figure 6. The view through a standard finder scope and reflector telescope is rotated 180°. This is true for the SkyView Pro 8 EQ and its finder scope as well.

If you have trouble focusing, rotate the focusing knob so the drawtube is in as far as it will go. Now look through the eyepiece while slowly rotating the focusing knob in the opposite direction. You should soon see the point at which focus is reached.

The black nylon thumb screw on the top of the body of the focuser (see Figure 4) will lock the focuser drawtube in place once the telescope is properly focused. Before focusing, remember to first loosen this thumb screw.

Viewing with Eyeglasses

If you wear eyeglasses, you may be able to keep them on while you observe, if the eyepiece has enough “eye relief” to allow you to see the whole field of view. You can try this by looking through the eyepiece first with your glasses on, and then with them off, and see if the glasses restrict the view to only a portion of the full field. If they do, you can easily observe with your glasses off by just re-focusing the telescope the needed amount. If you suffer from severe astigmatism, however, you may find images noticeably sharper with your glasses on.

Aligning the Finder Scope

The SkyView Pro 8 EQ Deluxe comes with a 8x40 achromatic finder scope (Figure 3a). The number 8 means eight-times mag-

nification and the 40 indicates a 40mm diameter front lens. The finder scope makes it easier to locate the subject you want to observe in the telescope, because the finder scope has a much wider field-of-view.

The SkyView Pro 8 EQ's finder scope uses a spring-loaded bracket that makes alignment of the finderscope very easy. As you turn either of the thumbscrews, the spring in the bracket's tensioner moves in and out to keep the finder scope secure in the bracket.

The finder scope must be aligned accurately with the telescope for proper use. To align it, first aim the main telescope in the general direction of an object at least a 1/4 mile away - the top of a telephone pole, a chimney, etc. To aim the telescope, loosen the R.A. and Dec. lock levers and move it until it is pointing at the desired object. Then sight along the tube to aim the telescope. Turn the focus knob until the object is properly focused. Make sure to position the object in the center of the telescope's eyepiece by turning the R.A. and Dec. slow-motion control knobs.

Now look in the finder scope. Is the object visible? Ideally it will be somewhere in the field of view. If not, some coarse adjustment to the finder scope bracket's alignment thumbscrews will be needed until the object comes into the finder scope's field of view.

With the image in the finder scope's field of view, you now need to fine-adjust the alignment thumbscrews to center the object on the intersection of the crosshairs. Adjust the aim of the finder scope by turning the thumbscrews, one at a time, until the object is centered.

The finder scope alignment needs to be checked before every observing session. This can easily be done at night, before viewing through the telescope. Choose any bright star or planet, center the object in telescope eyepiece, and then adjust the finder scope bracket's alignment thumbscrews until the star or planet is centered on the finder's crosshairs.

Focusing the finder scope

If, when you look through the finder scope, the images appear somewhat out of focus, you will need to refocus the finder scope for your eyes. Loosen the lock ring located behind the objective lens cell on the body of the finder scope (see Figure 3a). Back the lock ring off by a few turns, for now. Refocus the finder scope on a distant object by threading the objective lens cell in or out of the finderscope body. Precise focusing will be achieved by focusing the finder scope on a bright star. Once the image appears sharp, retighten the locking ring behind the objective lens cell. The finder scope's focus should not need to be adjusted again.

Magnification & Eyepieces

Magnification, or power, is determined by the focal length of the telescope and the focal length of the eyepiece. Therefore, by using eyepieces of different focal lengths, the resultant magnification can be varied.

Magnification is calculated as follows:

$$\frac{\text{Telescope Focal Length (mm)}}{\text{Eyepiece Focal Length (mm)}} = \text{Magnification}$$

The SkyView Pro 8 EQ has a focal length of 1000mm, which when used with the supplied 25mm eyepiece yields:

$$\frac{1000\text{mm}}{25\text{mm}} = 40\text{x}$$

The magnification provided by the 10mm eyepiece is:

$$\frac{1000\text{mm}}{10\text{mm}} = 100\text{x}$$

The maximum attainable magnification for a telescope is directly related to how much light it can gather. The larger the aperture, the more magnification is possible. In general a figure of 50x per inch of aperture is the maximum attainable for most telescopes. Your SkyView Pro 8 EQ has an aperture of 8 inches, so the maximum magnification would be about 400x. This level of magnification assumes you have ideal conditions for viewing.

Keep in mind that as you increase magnification, the brightness of the object viewed will decrease; this is an inherent principle of the laws of physics and cannot be avoided. If magnification is doubled, an image appears four times dimmer. If magnification is tripled, image brightness is reduced by a factor of nine!

Start by centering the object being viewed in the 25mm eyepiece. Then you may want to increase the magnification to get a closer view. If the object is off-center (i.e., it is near the edge of the field of view) you will lose it when you increase magnification since the field of view will be narrower with the higher-powered eyepiece. To change eyepieces, first loosen the securing thumbscrew on the focuser. Then carefully lift the eyepiece out of the holder. Do not tug or pull the eyepiece to the sides, as this will knock the telescope off its target. Replace the eyepiece with the new one by sliding it gently into the holder. Re-tighten the thumbscrew, and refocus for your new magnification.

Using 2" eyepieces

The SkyView Pro 8 EQ's focuser is capable of accepting optional 2" eyepieces. To use 2" eyepieces you must remove the 1.25" adapter from the focuser by loosening the two thumbscrews that hold it in place. Once this adapter is removed, insert a 2" eyepiece into the focuser and use the same thumbscrews to secure the larger eyepiece.

6. Setting Up and Using the Equatorial Mount

When you look at the night sky, you no doubt have noticed that the stars appear to move slowly from east to west over time. That apparent motion is caused by the Earth's rotation (from west to east). An equatorial mount (Figure 7) is designed to compensate for that motion, allowing you to easily "track" the movement of astronomical objects, thereby keeping them from drifting out of your telescope's field of view while you're observing.

This is accomplished by slowly rotating the telescope on its right ascension (R.A.) axis, using only the R.A. slow-motion control knob. But first the R.A. axis of the mount must be aligned with the Earth's rotational (polar) axis - a process called polar alignment.

Polar Alignment

For Northern Hemisphere observers, approximate polar alignment is achieved by pointing the mount's right ascension axis at the North Star, or Polaris. It lies within 1° of the north celestial pole (NCP), which is an extension of the Earth's rotational axis out into space. Stars in the Northern Hemisphere appear to revolve around the NCP.

To find Polaris in the sky, look north and locate the pattern of the Big Dipper (Figure 8). The two stars at the end of the "bowl" of the Big Dipper point right to Polaris.

Observers in the Southern Hemisphere aren't so fortunate to have a bright star so near the south celestial pole (SCP). The

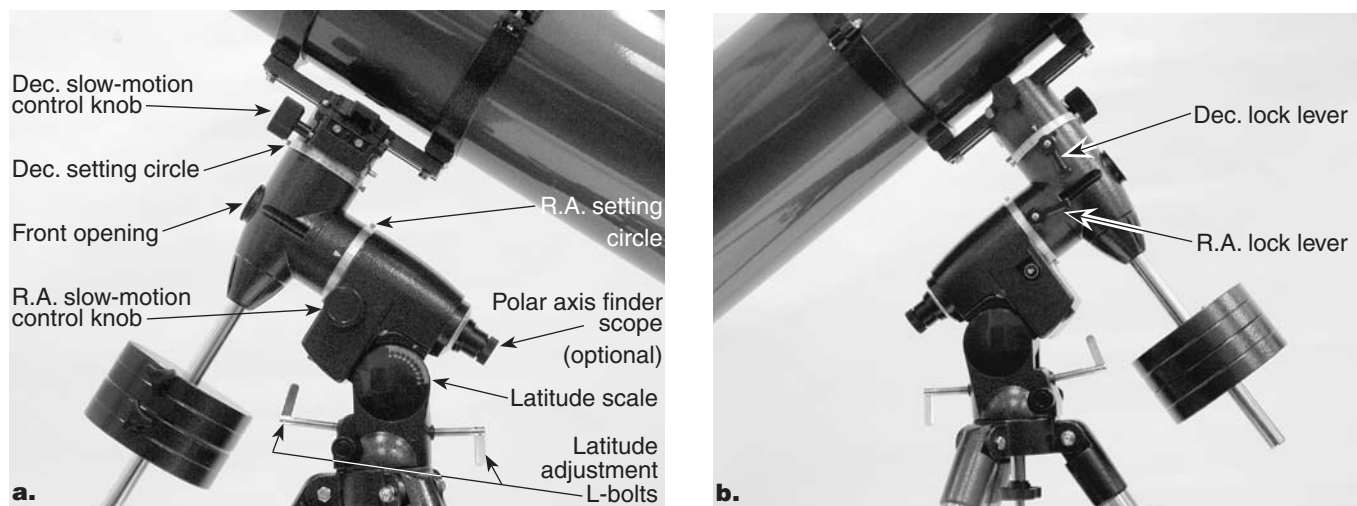

Figure 7. The SkyView Pro Equatorial Mount, shown from both sides.

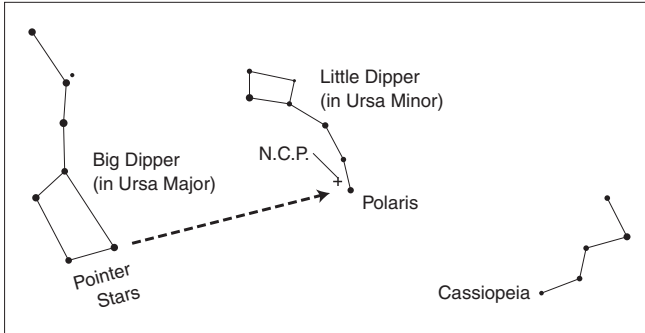

Figure 8. To find Polaris in the night sky, look north and find the Big Dipper. Extend an imaginary line from the two "Pointer Stars" in the bowl of the Big Dipper. Go about five times the distance between those stars and you'll reach Polaris, which lies within 1° of the north celestial pole (NCP).

star Sigma Octantis lies about 1° from the SCP, but it is barely visible with the naked eye (magnitude 5.5).

For general visual observation, an approximate polar alignment is sufficient.

1. Level the equatorial mount by adjusting the length of the three tripod legs.
2. There are two latitude adjusting L-bolts (see Figure 7); loosen one while tightening the other. By doing this you will adjust the latitude of the mount. Continue adjusting the mount until the pointer on the latitude scale is set at the latitude of your observing site. If you don't know your latitude, consult a geographical atlas to find it. For example, if your latitude is 35° North, set the pointer to 35. The latitude setting should not have to be adjusted again unless you move to a different viewing location some distance away.
3. Loosen the Dec. lock lever and rotate the telescope's optical tube until it is parallel with the right ascension axis, as it is in Figure 7.
4. Move the tripod so the telescope tube and right ascension axis point roughly at Polaris. If you cannot see Polaris

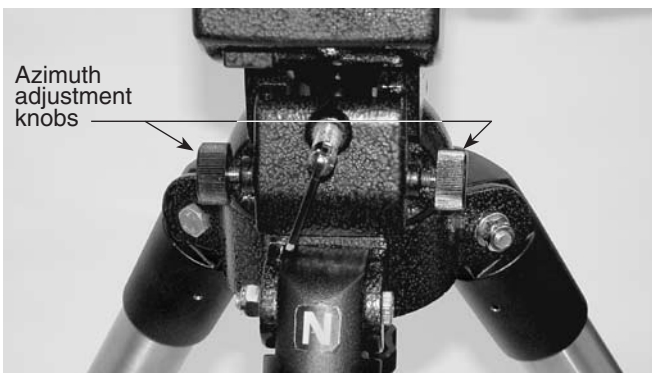

Figure 9. For polar alignment, position the tripod so that the "N" label at the base of the mount faces north. The azimuth fine adjustment knobs above it are used to make small adjustments to the mount's azimuth position. Be certain to loosen the tripod attachment knob on the central support shaft before adjusting these knobs.

directly from your observing site, consult a compass and rotate the tripod so the telescope points north. There is a label bearing a large "N" at the base of the equatorial mount (Figure 9). It should be facing north.

The equatorial mount is now polar aligned for casual observing. More precise polar alignment is recommended for astrophotography. For this we suggest using the optional polar axis finder scope.

From this point on in your observing session, you should not make any further adjustments to the latitude of the mount, nor should you move the tripod. Doing so will undo the polar alignment. The telescope should be moved only about its R.A. and Dec. axes.

Polar Alignment Using the Optional Polar Axis Finder Scope

The SkyView Pro EQ mount can be equipped with an optional polar axis finder scope (Figure 10a) which goes inside the right ascension axis of the mount. It makes accurate polar alignment quick and easy to do.

To install the polar axis finder scope, remove the cover at the

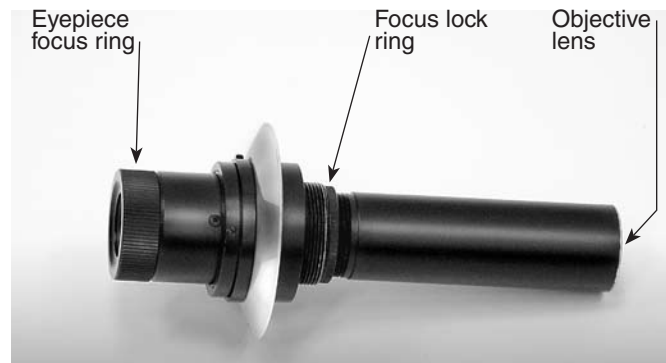

Figure 10a. The optional polar axis finder scope.

rear of the mount's right ascension axis and thread the polar axis finder scope into the equatorial mount until tight (Figure 10b).



Figure 10b. Installing the optional polar axis finder scope.

The reticle of the polar axis finder scope has a tiny star map printed on it that makes precise polar alignment quick and easy. If you do not have a clear view of Polaris from your



Figure 11. The optical tube must be at a 90° angle to the right ascension axis in order to view through the polar axis finder

observing site, you will not be able to use the polar-axis finder to precisely polar align the telescope. To align the mount using the polar axis finder scope, follow these instructions:

1. Approximately polar-align the mount as outlined in the procedure earlier.
2. Loosen the Dec. lock lever and rotate the optical tube on the declination axis so that the tube is at a 90° to the right ascension axis (Figure 11). Tighten the Dec. lock lever.

Remove the cap on the front opening of the equatorial mount (Figure 7). Focus the polar finder by rotating the eyepiece. Now, sight Polaris in the polar axis finder scope. If you have followed the approximate polar alignment procedure accurately, Polaris will probably be within the field of view. If not, move the tripod left-to-right, and adjust the latitude up-and down until Polaris is somewhere within the field of view of the polar axis finder scope.

Shine a red flashlight down the front end of the polar finder to illuminate the reticle within the field of view. Make sure the flashlight shines in at an angle, so as not to block the polar finder's field of view. It may be helpful to have a friend hold the flashlight while you look through the polar finder. Note the constellation Cassiopeia and the Big Dipper in the reticle. They do not appear to scale, but they indicate the general positions of Cassiopeia and the Big Dipper relative to the north celestial pole (which is indicated by the cross at the center

of the reticle). Rotate the reticle so the constellations depicted match their current orientation in the sky when viewed with the naked eye. To do this, release the R.A. lock lever and rotate the main telescope around the R.A. axis until the reticle is oriented with sky. For larger optical tubes, you may need to remove the tube from the mount to prevent it from bumping into the mount. Once the reticle is correctly oriented, use the right ascension lock lever to secure the mount's position.

Now use the azimuth adjustment knobs (Figure 9) and the latitude adjustment L-bolts (Figure 7) on the mount to position the star Polaris inside the tiny circle marked "Polaris" on the finder's reticle. You must first loosen the knob underneath the equatorial mount on the center support shaft to use the azimuth adjustment knobs. Once Polaris is properly positioned within the reticle, you are precisely polar aligned.

Note: From this point on in your observing session, you should not make any further adjustments in the azimuth or the latitude of the mount, nor should you move the tripod. Doing so will undo the polar alignment. The telescope should be moved only about its right ascension and declination axes.

Additional Note Regarding Focusing the Polar Axis Finder Scope

The polar axis finder scope is normally focused by simply rotating the eyepiece focus ring. However, if after adjusting the focus ring you find that the image of the reticle is sharp, but the stars are out of focus, then you must adjust the focus of the polar axis finder's objective lens. To do this, first remove the polar axis finder from the mount. Look through the polar axis finder at a star (at night) or distant object at least 1/4 mile away (during daylight). Use the eyepiece focus ring to bring the reticle into sharp focus. Now, loosen the focus lock ring (Figure 10a) and thread the entire objective end of the finder inwards or outwards until images appear sharp. Re-tighten the focus lock ring. Once the polar axis finder's objective lens is focused, it should not need to be adjusted again.

Use of the Right Ascension and Declination Slow-Motion Control Knobs

The right ascension (R.A.) and declination (Dec.) slow-motion control knobs allow fine adjustment of the telescope's position to center objects within the field of view. Before you can use the knobs, you must manually "slew" the mount to point the telescope in the vicinity of the desired target. Do this by loosening the R.A. and Dec. lock levers and moving the telescope about the mount's right ascension and declination axes. Once the telescope is pointed close to the object to be viewed, retighten both lock levers.

The object should now be visible somewhere in the telescope's finder scope. If it isn't, use the slow-motion knobs to scan the surrounding area of sky. When the object is visible in the finder scope, use the slow-motion knobs to center it. Now, look in the telescope's eyepiece. If the finder scope is properly aligned, the object should be visible somewhere in the field of view. Once the object is visible in the eyepiece, use the slow-motion knobs to center it in the field of view.

Note: If you have an optional motor drive attached, you will need to loosen the clutch on the R.A. (and Dec. for dual-axis drives) gear shaft before using the slow-motion control knob.

Tracking Celestial Objects

When you observe a celestial object through the telescope, you'll see it drift slowly across the field of view. To keep it in the field, if your equatorial mount is polar aligned, just turn the R.A. slow-motion control knob clockwise. The Dec. slow-motion control knob is not needed for tracking. Objects will appear to move faster at higher magnifications, because the field of view is narrower.

Optional Motor Drives for Automatic Tracking

An optional DC motor drive can be mounted on the R.A. axis of the equatorial mount to provide hands-free tracking. Objects will then remain stationary in the field of view without any manual adjustment of the right ascension slow-motion control knob.

Understanding the Setting Circles

The setting circles on an equatorial mount enable you to locate celestial objects by their "celestial coordinates". Every object resides in a specific location on the "celestial sphere". That location is denoted by two numbers: its right ascension (R.A.) and declination (Dec.). In the same way, every location on Earth can be described by its longitude and latitude. Right ascension is similar to longitude on Earth, and declination is similar to latitude. The R.A. and Dec. values for celestial objects can be found in any star atlas or star catalog.

The R.A. setting circle is scaled in hours, from 1 through 24, with small marks in between representing 10-minute increments (there are 60 minutes in 1 hour of right ascension). The lower set of numbers apply to viewing in the Northern Hemisphere, while the numbers above them apply to viewing in the Southern Hemisphere.

The Dec. setting circle is scaled in degrees, with each mark representing 2° increments. Values of declination coordinates range from +90° to -90°. The 0° mark indicates the celestial equator. When the telescope is pointed north of the celestial equator, values of the declination setting circle are positive; when the telescope is pointed south of the celestial equator, values of the declination setting circle are negative.

So, the coordinates for the Orion Nebula listed in a star atlas will look like this:

R.A. 5h 35.4m Dec. - 5° 27'

That's 5 hours and 35.4 minutes in right ascension, and -5 degrees and 27 arc-minutes in declination (there are 60 arc-minutes in 1 degree of declination).

Before you can use the setting circles to locate objects, the mount must be accurately polar aligned, and the setting circles must be calibrated.

Calibrating the Declination Setting Circle

1. Loosen the Dec. lock lever and position the telescope as accurately as possible in declination so it is parallel to the R.A. axis as shown in Figure 1. Re-tighten the lock lever.
2. Loosen one of the thumbscrews on the Dec. setting circle (see Figure 12), this will allow the setting circle to rotate freely. Rotate the Dec. setting circle until the pointer reads exactly 90°. Re-tighten the setting circle thumbscrew.

Calibrating the Right Ascension Setting Circle

1. Identify a bright star in the sky near the celestial equator (declination = 0°) and look up its coordinates in a star atlas.
2. Loosen the R.A. and Dec. lock levers on the equatorial mount, so the telescope optical tube can move freely.
3. Point the telescope at the bright star whose coordinates you know. Lock the R.A. and Dec. lock levers. Center the star in the telescope's field of view with the slow-motion control knobs.
4. Loosen one of the R.A. setting circle thumbscrews (see Figure 12); this will allow the setting circle to rotate freely. Rotate the setting circle until the R.A. pointer arrow indicates the R.A. coordinate listed in the star atlas for the object. Re-tighten the setting circle thumbscrew.

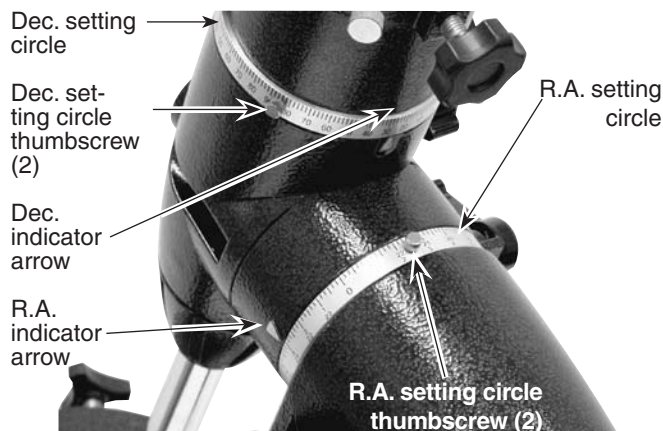

Figure 12. The R.A. and Dec. setting circles.

Finding Objects With the Setting Circles

Now that both setting circles are calibrated, look up in a star atlas the coordinates of an object you wish to view.

Loosen the Dec. lock lever and rotate the telescope until the declination value from the star atlas matches the reading on the Dec. setting circle. Remember that values of the Dec. setting circle are positive when the telescope is pointing north of the celestial equator (Dec. = 0°), and negative when the telescope is pointing south of the celestial equator. Retighten the lock lever.

Loosen the R.A. lock lever and rotate the telescope until the right ascension value from the star atlas matches the reading on the R.A. setting circle. Remember to use the lower set of numbers on the R.A. setting circle. Retighten the lock lever.

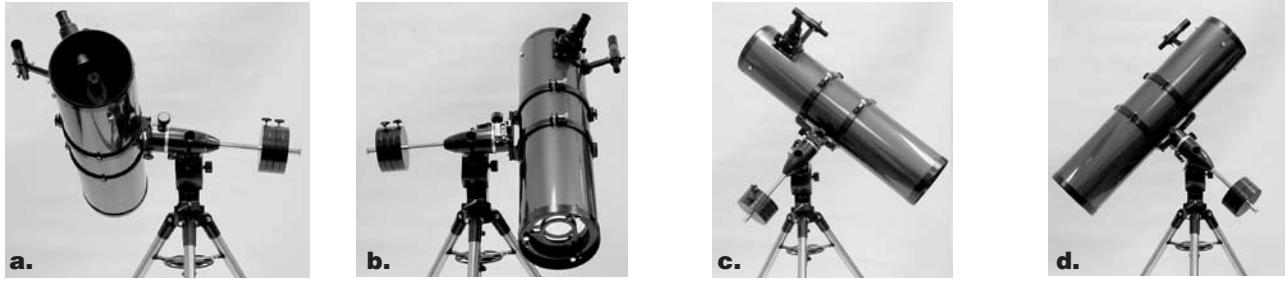

Figure 13. This illustration shows the telescope pointed in the four cardinal directions (a) north, (b) south, (c) east, (d) west. Note that the tripod and mount have not been moved; only the telescope tube has been moved on the R.A. and Dec. axes.

Most setting circles are not accurate enough to put an object dead-center in the telescope's eyepiece, but they should place the object somewhere within the field of view of the finder scope, assuming the equatorial mount is accurately polar aligned. Use the slow-motion controls to center the object in the finder scope, and it should appear in the telescope's field of view.

The setting circles must be re-calibrated every time you wish to locate a new object. Do so by calibrating the setting circles for the centered object before moving on to the next one.

Confused About Pointing the Telescope?

Beginners occasionally experience some confusion about how to point the telescope overhead or in other directions. In Figure 1 the telescope is pointed north as it would be during polar alignment. The counterweight shaft is oriented downward. But it will not look like that when the telescope is pointed in other directions. Let's say you want to view an object that is directly overhead, at the zenith. How do you do it?

DO NOT make any adjustment to the latitude adjustment L-bolts. That will spoil the mount's polar alignment. Remember, once the mount is polar aligned, the telescope should be moved only on the R.A. and Dec. axes. To point the scope overhead, first loosen the R.A. lock lever and rotate the telescope on the right ascension axis until the counterweight shaft is horizontal (parallel to the ground). Then loosen the Dec. lock lever and rotate the telescope until it is pointing straight overhead. The counterweight shaft is still horizontal. Then retighten both lock levers.

What if you need to aim the telescope directly north, but at an object that is nearer to the horizon than Polaris? You can't do it with the counterweights down as pictured in Figure 1. Again, you have to rotate the scope in right ascension so that the counterweight shaft is positioned horizontally. Then rotate the scope in declination so it points to where you want it near the horizon.

To point the telescope directly south, the counterweight shaft should again be horizontal. Then you simply rotate the scope on the declination axis until it points in the south direction.

To point the telescope to the east or west, or in other directions, you rotate the telescope on its right ascension and declination axes. Depending on the altitude of the object you want to observe, the counterweight shaft will be oriented somewhere between vertical and horizontal.

Figure 13 illustrates how the telescope will look when pointed at the four cardinal directions: north, south, east and west.

7. Collimation (Aligning The Mirrors)

Collimation is the process of adjusting the mirrors so they are perfectly aligned with one another. Your telescope's optics were aligned at the factory, and should not need much adjustment unless the telescope is handled roughly. Accurate mirror alignment is important to ensure the peak performance of your telescope, so it should be checked regularly. Collimation is relatively easy to do and can be done in daylight.

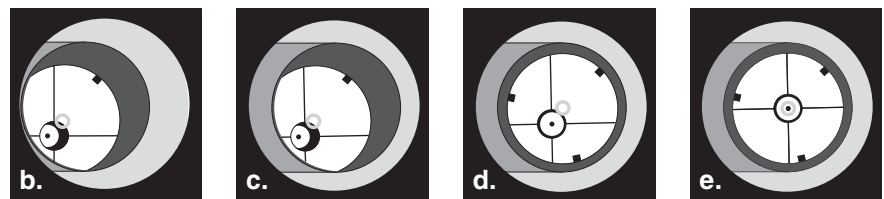
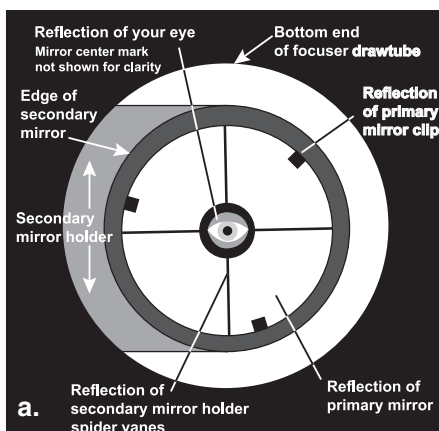

Figure 14. Collimating the optics. (a) When the mirrors are properly aligned, the view down the focuser drawtube should look like this (b) With the collimation cap in place, if the optics are out of alignment, the view might look something like this. (c) Here, the secondary mirror is centered under the focuser, but it needs to be adjusted (tilted) so that the entire primary mirror is visible. (d) The secondary mirror is correctly aligned, but the primary mirror still needs adjustment. When the primary mirror is correctly aligned, the "dot" will be centered, as in (e).

To check collimation, remove the eyepiece and look down the focuser drawtube. You should see the secondary mirror centered in the drawtube, as well as the reflection of the primary mirror centered in the secondary mirror, and the reflection of the secondary mirror (and your eye) centered in the reflection of the primary mirror, as in Figure 14a. If anything is off-center, as in Figure 14b, proceed with the following collimation procedure.

Note About the Collimatable 2" Focuser

The SkyView Pro 8's 2" focuser can be collimated by 3 pairs of push-pull screws located on the ring at the base of the focuser (Figure 4). The focuser was collimated at the factory and should never need to be adjusted. Focuser collimation is only required under very rare circumstances but has been made available for this telescope should such a need arise.

The Collimation Cap and Mirror Center Mark

Your SkyView Pro 8 EQ comes with a collimation cap. This is a simple cap that fits on the focuser drawtube like a dust cap, but has a hole in the center and a silver bottom. This helps center your eye so that collimation is easy to perform. Figures 14b through 14e assume you have the collimation cap in place.

In addition to the collimation cap, the primary mirror is marked with a circle at its exact center. This "center mark" allows you to achieve a precise collimation of the primary mirror; you don't have to guess where the center of the mirror is. You simply adjust the mirror position (described below) until the reflection of the hole in the collimation cap is centered in the ring. The center mark is also required for best results when using other collimating devices, such as Orion's LaserMate Laser Collimator, obviating the need to remove the primary mirror and mark it yourself.

Note: The center ring sticker need not ever be removed from the primary mirror. Because it lies directly in the shadow of the secondary mirror, its presence in no way adversely affects the optical performance of the telescope or the image quality. That might seem counterintuitive, but it's true!

Aligning the Secondary Mirror

With the collimation cap in place, look through the hole in the cap at the secondary (diagonal) mirror. Ignore the reflections for the time being. The secondary mirror itself should be centered in the focuser drawtube, in the direction parallel to the length of the telescope. If it isn't, as in Figure 14b, it must be adjusted. This adjustment will rarely, if ever, need to be done.

It helps to adjust the secondary mirror in a brightly lit room with the telescope pointed towards a bright surface, such as white paper or wall. Also placing a piece of white paper in the telescope tube opposite the focuser (in other words, on the other side of the secondary mirror) will also be helpful in collimating the secondary mirror. Using a 2mm hex key, loosen the three small alignment set screws in the center hub of the 4-vaned spider several turns. Now keep the mirror's holder stationary (be careful not to touch the surface of the mirrors),

while turning the center screw with a Phillips head screwdriver (See Figure 15). Turning the screw clockwise will move the secondary mirror toward the front opening of the optical tube, while turning the screw counter-clockwise will move the secondary mirror toward the primary mirror.

Note: When making these adjustments, be careful not to stress the spider vanes or they may bend.



Figure 15. To center the secondary mirror under the focuser, hold the secondary mirror holder in place with one hand while adjusting the center bolt with a Phillips screwdriver. Do not touch the mirror's surface!

When the secondary mirror is centered in the focuser drawtube, rotate the secondary mirror holder until the reflection of the primary mirror is as centered in the secondary mirror as possible. It may not be perfectly centered, but that is OK. Now tighten the three small alignment screws equally to secure the secondary mirror in that position.

If the entire primary mirror reflection is not visible in the secondary mirror, as in Figure 14c, you will need to adjust the tilt of the secondary mirror. This is done by alternately loosening one of the three alignment set screws while tightening the other two, as depicted in Figure 16. The goal is to center the primary mirror reflection in the secondary mirror, as in Figure 14d. Don't worry that the reflection of the secondary mirror (the smallest circle, with the collimation cap "dot" in the center) is off-center. You will fix that in the next step.



Figure 16. Adjust the tilt of the secondary mirror by loosening or tightening the three alignment set screws with a 2mm hex key.

Adjusting the Primary Mirror

The final adjustment is made to the primary mirror. It will need adjustment if, as in Figure 14d, the secondary mirror is centered under the focuser and the reflection of the primary mirror is centered in the secondary mirror, but the small reflection of the secondary mirror (with the “dot” of the collimation cap) is off-center.

The tilt of the primary mirror is adjusted with three spring-loaded collimation thumbscrews on the back end of the optical tube (bottom of the primary mirror cell); these are the larger thumbscrews. The other three smaller thumbscrews lock the mirror’s position in place; these thumbscrews must be loosened before any collimation adjustments can be made to the primary mirror.

To start, turn the smaller thumbscrews that lock the primary mirror in place a few turns each (Figure 17). Use a screwdriver in the slots, if necessary.

Now, try tightening or loosening one of the larger collimation thumbscrews with your fingers (Figure 18). Look into the



Figure 17. The three small thumbscrews that lock the primary mirror in place must first be loosened before any adjustments can be made.

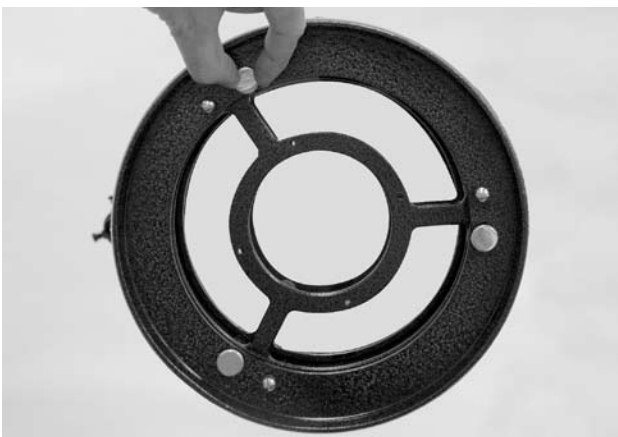

Figure 18. The tilt of the primary mirror is adjusted by turning one or more of the three larger thumbscrews.

focuser and see if the secondary mirror reflection has moved closer to the center of the primary. You can tell this easily with the collimation cap and mirror center mark by simply watching to see if the “dot” of the collimation cap is moving closer or further away from the “ring” on the center of the primary mirror mark. When you have the dot centered as much as is possible in the ring, your primary mirror is collimated. The view through the collimation cap should resemble Figure 14e. Re-tighten the locking thumbscrews.

A simple star test will tell you whether the optics are accurately collimated.

Star-Testing the Telescope

When it is dark, point the telescope at a bright star and accurately center it in the eyepiece’s field-of-view. Slowly defocus the image with the focusing knob. If the telescope is correctly collimated, the expanding disk should be a perfect circle (Figure 19). If the image is unsymmetrical, the scope is out of collimation. The dark shadow cast by the secondary mirror should appear in the very center of the out-of-focus circle, like the hole in a doughnut. If the “hole” appears off-center, the telescope is out of collimation.

If you try the star test and the bright star you have selected is not accurately centered in the eyepiece, then the optics will always appear out of collimation, even though they may be perfectly aligned. It is critical to keep the star centered, so over time you will need to make slight corrections to the telescope’s position in order to account for the sky’s apparent motion.

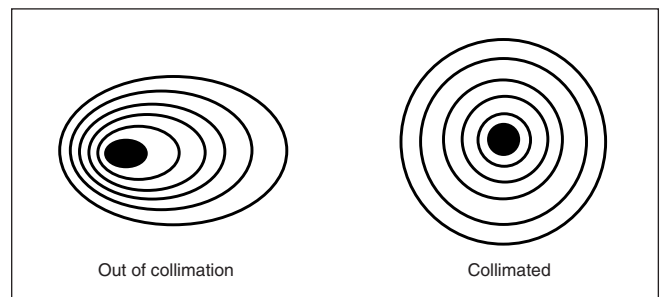

Figure 19. A star test will determine if a telescope’s optics are properly collimated. An unfocused view of a bright star through the eyepiece should appear as illustrated on the right if the optics are perfectly collimated. If the circle is unsymmetrical, as in the illustration on the left, the scope needs collimation.

8. Astronomical Observing

For many users, the SkyView Pro 8 EQ telescope will be a major leap into the world of amateur astronomy. This section is intended to get you ready for your voyages through the night sky.

Site Selection

Pick a location away from street lights and bright yard lighting. Avoid viewing over rooftops and chimneys, as they often have warm air currents rising from them, which distort the image seen in the eyepiece. Similarly, you should not observe through an open window from indoors. Better yet, choose a site out-of-town, away from any "light pollution". You'll be stunned at how many more stars you'll see! Most importantly, make sure that any chosen site has a clear view of a large portion of the sky.

Seeing and Transparency

Atmospheric conditions play a huge part in quality of viewing. In conditions of good "seeing", star twinkling is minimal and objects appear steady in the eyepiece. Seeing is best overhead, worst at the horizon. Also, seeing generally gets better after midnight, when much of the heat absorbed by the Earth during the day has radiated off into space. Typically, seeing conditions will be better at sites that have an altitude over about 3000 feet. Altitude helps because it decreases the amount of distortion causing atmosphere you are looking through.

A good way to judge if the seeing is good or not is to look at bright stars about 40° above the horizon. If the stars appear to "twinkle", the atmosphere is significantly distorting the incoming light, and views at high magnifications will not appear sharp. If the stars appear steady and do not twinkle, seeing conditions are probably good and higher magnifications will be possible. Also, seeing conditions are typically poor during the day. This is because the heat from the Sun warms the air and causes turbulence.

Good "transparency" is especially important for observing faint objects. It simply means the air is free of moisture, smoke, and dust. All tend to scatter light, which reduces an object's brightness.

One good way to tell if conditions are good is by how many stars you can see with your naked eye. If you cannot see stars of magnitude 3.5 or dimmer then conditions are poor. Magnitude is a measure of how bright a star is, the brighter a star is, the lower its magnitude will be. A good star to remember for this is Megrez (mag. 3.4), which is the star in the "Big Dipper" connecting the handle to the "dipper". If you cannot see Megrez, then you have fog, haze, clouds, smog, light pollution or other conditions that are hindering your viewing (See Figure 20).

Cooling the Telescope

All optical instruments need time to reach "thermal equilibrium" to achieve maximum stability of the lenses and mirrors, which is essential for peak performance. When moved from a warm indoor location outside to cooler air (or vice-versa), a telescope needs time to cool to the outdoor temperature. The

Big Dipper
(in Ursa Major)

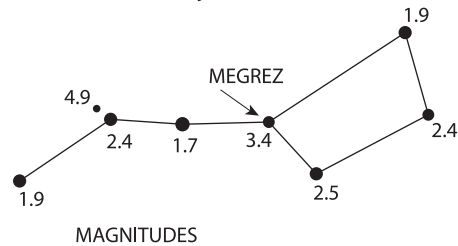

Figure 20. Megrez connects the Big Dipper's handle to its "pan". It is a good guide to how conditions are. If you can not see Megrez (a 3.4 mag star) then conditions are poor.

bigger the instrument and the larger the temperature change, the more time will be needed.

Allow at least 30 minutes for your SkyView Pro 8 EQ to equilibrate. If the scope has more than a 40° temperature adjustment, allow an hour or more. In the winter, storing the telescope outdoors in a shed or garage greatly reduces the amount of time needed for the optics to stabilize. It also is a good idea to keep the scope covered until the Sun sets so the tube does not heat greatly above the temperature of the outside air.

You can attach a small fan to the SkyView Pro 8 EQ to make cooling the tube faster. On the bottom of the mirror cell there are four holes (M4 x. 7 thread) where a fan can be mounted.

Let Your Eyes Dark-Adapt

Do not expect to go from a lighted house into the darkness of the outdoors at night and immediately see faint nebulas, galaxies, and star clusters - or even very many stars, for that matter. Your eyes take about 30 minutes to reach perhaps 80% of their full dark-adapted sensitivity. Many observers notice improvements after several hours of total darkness. As your eyes become dark-adapted, more stars will glimmer into view and you will be able to see fainter details in objects you view in your telescope. Exposing your eyes to very bright daylight for extended periods of time can adversely affect your night vision for days. So give yourself at least a little while to get used to the dark before you begin observing.

To see what you are doing in the darkness, use a red-filtered flashlight rather than a white light. Red light does not spoil your eyes' dark adaptation like white light does. A flashlight with a red LED light is ideal, or you can cover the front of a regular incandescent flashlight with red cellophane or paper. Beware, too, that nearby porch and streetlights and automobile headlights will spoil your night vision.

Eyepiece Selection

By using eyepieces of varying focal lengths, it is possible to attain many magnifications with the SkyView Pro 8 EQ. The telescope comes with two high quality Sirius Plössl eyepieces: a 25mm, which gives a magnification of 40x, and a 10mm, which gives a magnification of 100x. Other eyepieces can be

used to achieve higher or lower powers. It is quite common for an observer to own five or more eyepieces to access a wide range of magnifications. This allows the observer to choose the best eyepiece to use depending on the object being viewed. At least to begin with, the two supplied eyepieces will suffice nicely.

Whatever you choose to view, always start by inserting your lowest power (longest focal length) eyepiece to locate and center the object. Low magnification yields a wide field of view, which shows a larger area of sky in the eyepiece. This makes acquiring and centering an object much easier. If you try to find and center objects with high power (narrow field of view), it's like trying to find a needle in a haystack!

Once you've centered the object in the eyepiece, you can switch to higher magnification (shorter focal length eyepiece), if you wish. This is especially recommended for small and bright objects, like planets and double stars. The Moon also takes higher magnifications well.

Deep-sky objects, however, typically look better at medium or low magnifications. This is because many of them are quite faint, yet have some extent (apparent width). Deep-sky objects will often disappear at higher magnifications, since greater magnification inherently yields dimmer images. This is not the case for all deep-sky objects, however. Many galaxies are quite small, yet are somewhat bright, so higher power may show more detail.

The best rule of thumb with eyepiece selection is to start with a low power, wide field, and then work your way up in magnification. If the object looks better, try an even higher magnification. If the object looks worse, then back off the magnification a little by using a lower power eyepiece.

What to Expect

So what will you see with your telescope? You should be able to see bands on Jupiter, the rings of Saturn, craters on the moon, the waxing and waning of Venus, and possibly hundreds of deep sky objects. Do not expect to see as much color as you in NASA photos, since those are taken with long-exposure cameras and have "false color" added. Our eyes are not sensitive enough to see color in deep-sky objects except in a few of the brightest ones.

Remember that you are seeing these objects using your own telescope with your own eyes! The object you see in your eyepiece is in real-time, and not some conveniently provided image from an expensive space probe. Each session with your telescope will be a learning experience. Each time you work with your telescope it will get easier to use, and stellar objects will become easier to find. Take it from us, there is big difference between looking at a well-made full-color NASA image of a deep-sky object in a lit room during the daytime, and seeing that same object in your telescope at night. One can merely be a pretty image someone gave to you. The other is an experience you will never forget!

A. The Moon

With its rocky and cratered surface, the moon is one of the most interesting and easy subjects for your scope. The best time to view it is during its partial phases when shadows fall on the craters and canyon walls to give its features definition. While the full moon may look like a tempting target, it is actually the worst time for viewing! The light of a full moon is too bright and lacks any decent surface definition.

Use an optional Moon filter to dim the Moon when it is very bright. It simply threads onto the bottom of the eyepiece from the focuser (you must first remove the eyepiece from the focuser to attach the filter). You'll find the Moon filter improves viewing comfort, and helps bring out the subtle features of the lunar surface.

B. The Sun

You can change your nighttime telescope into a daytime Sun viewer by installing an optional full-aperture solar filter over the front opening of a SkyView Pro 8 EQ. The primary attraction is sunspots, which change shape, appearance, and location daily. Sunspots are directly related to magnetic activity in the Sun. Many observers like to make drawings of sunspots to monitor how the Sun is changing from day to day.

Important Note: Do not look at the Sun with any optical instrument without a professionally made solar filter, or permanent eye damage could result. Also, be sure to cover the finder scope, or better yet, remove it altogether.

C. The Planets

The planets don't stay put like the stars, so to find them you should refer to Sky Calendar at our website telescope.com, or to charts published monthly in *Astronomy*, *Sky & Telescope*, or other astronomy magazines. Venus, Mars, Jupiter, and Saturn are the brightest objects in the sky after the Sun and the Moon. Your SkyView Pro 8 EQ is capable of showing you these planets in some detail. Other planets may be visible but will likely appear starlike. Because planets are quite small in apparent size, optional higher power eyepieces are recommended and often needed for detailed observations. Not all the planets are generally visible at any one time.

JUPITER The largest planet, Jupiter, is a great subject for observation. You can see the disk of the giant planet and watch the ever-changing positions of its four largest moons - Io, Callisto, Europa, and Ganymede. Higher power eyepieces should bring out the cloud bands on the planet's disk.

SATURN The ringed planet is a breathtaking sight when it is well positioned. The tilt angle of the rings varies over a period of many years; sometimes they are seen edge-on, while at other times they are broadside and look like giant "ears" on each side of Saturn's disk. A steady atmosphere (good seeing) is necessary for a good view. You will probably see a bright "star" close by, which is Saturn's brightest moon, Titan.

VENUS At its brightest, Venus is the most luminous object in the sky, excluding the Sun and the Moon. It is so bright that sometimes it is visible to the naked eye during full daylight! Ironically, Venus appears as a thin crescent, not a full disk, when at its peak brightness.

Because it is so close to the Sun, it never wanders too far from the morning or evening horizon. No surface markings can be seen on Venus, which is always shrouded in dense clouds.

MARS The Red Planet makes its closest approach to Earth every two years. During close approaches you'll see a red disk, and may be able to see the polar ice cap. To see surface detail on Mars, you will need a high power eyepiece and very steady air!

D. The Stars

Stars will appear like twinkling points of light. Even powerful telescopes cannot magnify stars to appear as more than a point of light! You can, however, enjoy the different colors of the stars and locate many pretty double and multiple stars. The famous "Double-Double" in the constellation Lyra and the gorgeous two-color double star Albireo in Cygnus are favorites. Defocusing a star slightly can help bring out its color.

E. Deep-Sky Objects

Under dark skies, you can observe a wealth of fascinating deep-sky objects, including gaseous nebulas, open and globular star clusters, and a variety of different types of galaxies. Most deep-sky objects are very faint, so it is important that you find an observing site well away from light pollution. Take plenty of time to let your eyes adjust to the darkness. Do not expect these subjects to appear like the photographs you see in books and magazines; most will look like dim gray smudges. But as you become more experienced and your observing skills get sharper, you will be able to ferret out more and more subtle details and structure.

How to Find Deep-sky Objects: Starhopping

Starhopping, as it is called by astronomers, is perhaps the simplest way to hunt down objects to view in the night sky. It entails first pointing the telescope at a star close to the object you wish to observe, and then progressing to other stars closer and closer to the object until it is in the field of view of the eyepiece. It is a very intuitive technique that has been employed for hundreds of years by professional and amateur astronomers alike. Keep in mind, as with any new task, that starhopping may seem challenging at first, but will become easier over time and with practice.

To starhop, only a minimal amount of additional equipment is necessary. A star chart or atlas that shows stars to at least magnitude 5 is required. Select one that shows the positions of many deep-sky objects, so you will have a lot of options to choose from. If you do not know the positions of the constellations in the night sky, you will need to get a planisphere to identify them.

Start by choosing bright objects to view. The brightness of an object is measured by its visual magnitude; the brighter an object, the lower its magnitude. Choose an object with a visual magnitude of 9 or lower. Many beginners start with the Messier objects, which represent some of the best and brightest deep-sky objects, first catalogued about 200 years ago by the French astronomer Charles Messier.

Determine in which constellation the object lies. Now, find the constellation in the sky. If you do not recognize the constellations on sight, consult a planisphere. The planisphere gives an all-sky view and shows which constellations are visible on a given night at a given time.

Now, look at your star chart and find the brightest star in the constellation that is near the object you are trying to find. Using the finder scope, point the telescope at this star and center it on the crosshairs. Next, look again at the star chart and find another suitably bright star near the bright star currently centered in the finder. Keep in mind that the field of view of the finder scope is approximately 5° , so you should choose another star that is no more than 5° from the first star, if possible. Move the telescope slightly, until the telescope is centered on the new star.

Continue using stars as guideposts in this way until you are at the approximate position of the object you are trying to find (Figure 21). Look in the telescope's eyepiece, and the object should be somewhere within the field of view. If it's not, sweep the telescope carefully around the immediate vicinity until the object is found.

If you have trouble finding the object, start the starhop again from the brightest star near the object you wish to view. This time, be sure the stars indicated on the star chart are in fact the stars you are centering in the eyepiece. Remember, the finder scope (and main telescope eyepiece, for that matter) gives an inverted image, so you must keep this in mind when starhopping from star to star.

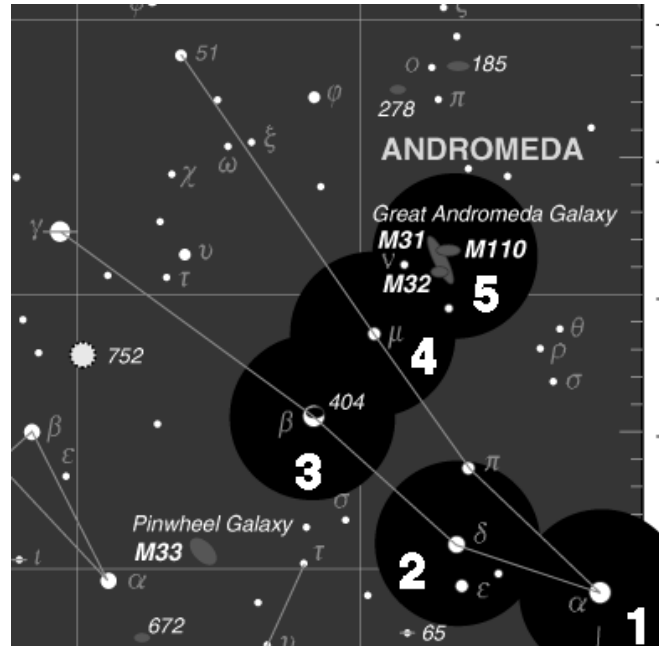

Figure 21. Starhopping is a good way to locate hard-to-find objects. Refer to a star chart to map a route to the object that uses bright stars as guideposts. Center the first star you've chosen in the finder scope and telescope eyepiece (1). Now move the scope carefully in the direction of the next bright star (2), until it is centered. Repeat (3 and 4). The last hop (5) should place the desired object in the eyepiece.

9. Astrophotography

When coupled to a 35mm single-lens reflex camera, the SkyView Pro becomes a telephoto lens. To attach a camera, you need only a T-ring for your specific camera model and the included camera adapter. First you must attach the included camera adapter to the SkyView Pro 8 EQ's focuser. To do this, remove the 1.25" and 2" eyepiece adapters from the focuser drawtube (Figure 22a). Then screw the camera adapter into the focuser drawtube (Figure 22b). Now attach the T-Ring to your camera and thread it onto the camera adapter (Figure 22c).

Use the camera's viewfinder to frame the picture. Use the telescope's focuser to focus the image. You may want to consider using a remote shutter release instead of the shutter release on the camera; touching the camera can vibrate the system and blur the resulting photographic image on the film. Use the focus lock knob on the focuser to lock the focus when the image is sharp.

Several different types of astrophotography can be successfully attempted with the SkyView Pro 8 EQ.

Moon Photography

This is perhaps the simplest form of astrophotography, as no motor drive is required. Point the telescope toward the Moon, and center it within the camera's viewfinder. Focus the image with the telescope's focuser. Try several exposure times, all less than 1 second, depending on the phase of the moon and the ISO (film speed) of the film being used. A remote shutter release is recommended, as touching the camera's shutter release can vibrate the camera enough to ruin the exposure.

Planetary Photography

Once basic Moon photography has been mastered, it's time to get images of the planets. This type of astrophotography also works to get highly magnified shots of the Moon. In addition to the T-ring, you will need a Universal 1.25" Camera Adapter. The EQ-3 Motor Drive System (single or dual axis) is also required. This is because a longer exposure is necessary, which would cause the image to blur if no motor drive was used for tracking. The equatorial mount must be accurately polar aligned, too.

As before, connect the T-ring to your camera. Before connecting the universal camera adapter to the T-ring, an eyepiece

must be inserted and locked into the body of the universal camera adapter. Start by using a medium-low power eyepiece (about 25mm); you can increase the magnification later with a high-power eyepiece. Then connect the entire camera adapter, with eyepiece inside, to the T-Ring. Insert the whole system into the focuser's 1.25" adapter and secure firmly with the thumbscrew.

Aim the telescope at the planet (or Moon) you wish to shoot. The image will be highly magnified, so you may need to use the finder scope to center it within the camera's viewfinder. Turn the motor drive on. Adjust the telescope's focuser so that the image appears sharp in the camera's viewfinder. The camera's shutter is now ready to be opened. A remote shutter release must be used or the image will be blurred beyond recognition. Try exposure times between 1 and 10 seconds, depending upon the brightness of the planet to be photographed and the ISO of the film being used.

"Piggyback Photography"

The Moon and planets are interesting targets for the budding astrophotographer, but what next? Literally thousands of deep-sky objects can be captured on film with a type of astrophotography called "piggybacking". The basic idea is that the camera with its own camera lens attached rides on top of the main telescope. The telescope and camera both move with the rotation of the Earth when the mount is polar aligned and the motor drive is engaged. This allows for a long exposure through the camera without having the object or background stars blurred. In addition to the motor drive (dual-axis), an illuminated reticle eyepiece is also needed. The T-ring and camera adapter are not needed, since the camera is exposing through its own lens. Any camera lens with a focal length between 35mm and 400mm is appropriate.

On the top of one of the tube rings is a piggyback camera adapter. This is the black knob with the threaded shaft protruding through it. The tube ring with the piggyback adapter should be closest to the open end of the telescope tube. Remove the tube rings from the equatorial mount and swap their position if necessary. Now, connect the camera to the piggyback adapter. There should be a 1/4"-20 mounting hole in the bottom of the camera's body. Thread the protruding shaft of the piggyback adapter into the 1/4"-20 mounting hole in the camera a few turns. Position the camera so it is parallel with the telescope tube and turn the knurled black knob of the piggyback adapter counter-clockwise until the camera is locked into position.



Figure 22a. First remove both the 1.25" and 2" adapters as shown



Figure 22b. Thread the camera adapter into the focuser drawtube



Figure 22c. The SkyView Pro 8 EQ with 35mm SLR camera attached

Aim the telescope at a deep-sky object. It should be a fairly large deep-sky object, as the camera lens will likely have a wide field of view. Check to make sure that the object is also centered in the camera's viewfinder. Turn the motor drive on. Now, look into the telescope's eyepiece and center the brightest star within the field of view. Remove the eyepiece and insert the illuminated reticle eyepiece into the focuser drawtube. Turn the eyepiece's illuminator on (dimly!). Recenter the bright star (guide star) on the crosshairs of the reticle eyepiece. Check again to make sure that the object to be photographed is still centered within the camera's field of view. If it is not, recenter it by repositioning the camera on the piggyback adapter, or by moving the main telescope. If you move the main telescope, then you will need to recenter another guide star on the illuminated eyepiece's crosshairs. Once the object is centered in the camera and a guide star is centered in the reticle eyepiece, you're ready to shoot.

Deep-sky objects are quite faint, and typically require exposures on the order of 10 minutes. To hold the camera's shutter open this long, you will need a lock shutter release cable. Set the camera's shutter to the "B" (bulb) setting. Depress the locking shutter release cable and lock it. You are now exposing your first deep-sky object.

While exposing through the camera lens, you will need to monitor the accuracy of the mount's tracking by looking through the illuminated reticle eyepiece in the main telescope. If the guide star drifts from its initial position, then use the hand controller of the motor drive to "move" the guide star back to the center of the crosshairs. Any drifting along the Dec. axis is a result of improper polar alignment, so if the guide star drifts greatly in Dec., the mount may need to be polar aligned more accurately.

When the exposure is complete, unlock the shutter release cable and close the camera's shutter.

Astrophotography can be enjoyable and rewarding, as well as frustrating and time-consuming. Start slowly and consult outside resources, such as books and magazines, for more details about astrophotography. Remember....have fun!

10. Care and Maintenance

If you give your telescope reasonable care, it will last a lifetime. Store it in a clean, dry, dust-free place, safe from rapid changes in temperature and humidity. Do not store the telescope outdoors, although storage in a garage or shed is OK. Small components like eyepieces and other accessories should be kept in a protective box or storage case. Keep the dust cover on the front of the telescope when not in use.

Your SkyView Pro 8 EQ requires very little mechanical maintenance. The optical tube is steel and has a smooth painted finish that is fairly scratch-resistant. If a scratch does appear on the tube, it will not harm the telescope. Smudges on the tube can be wiped off with a soft cloth and a household cleaner such as Windex or Formula 409.

Cleaning Lenses

Any quality optical lens cleaning tissue and optical lens cleaning fluid specifically designed for multi-coated optics can be used to clean the exposed lenses of your eyepieces or finder scope. Never use regular glass cleaner or cleaning fluid designed for eyeglasses. Before cleaning with fluid and tissue, however, blow any loose particles off the lens with a blower bulb or compressed air. Then apply some cleaning fluid to a tissue, never directly on the optics. Wipe the lens gently in a circular motion, then remove any excess fluid with a fresh lens tissue. Oily fingerprints and smudges may be removed using this method. Use caution; rubbing too hard may scratch the lens. On larger lenses, clean only a small area at a time, using a fresh lens tissue on each area. Never reuse tissues.

Cleaning Mirrors

You should not have to clean the telescope's mirrors very often; normally once every year or so. Covering the telescope with the dust cover when it is not in use will prevent dust from accumulating on the mirrors. Improper cleaning can scratch mirror coatings, so the fewer times you have to clean the mirrors, the better. Small specks of dust or flecks of paint have virtually no effect on the visual performance of the telescope.

The large primary mirror and the elliptical secondary mirror of your telescope are front-surface aluminized and over-coated with hard silicon dioxide, which prevents the aluminum from oxidizing. These coatings normally last through many years of use before requiring re-coating (which is easily done).

To clean the secondary mirror, first remove it from the telescope. Do this by holding the secondary mirror holder stationary while turning the center Phillips head screw. Be careful, there is a spring between the secondary mirror holder and the Phillips head screw. Be sure that the spring or the secondary holder will not fall into the optical tube and hit the primary mirror. Handle the mirror by its holder; do not touch the mirror surface. Then follow the same procedure described below for cleaning the primary mirror. You do not need to remove the secondary mirror from its holder when cleaning.

To clean the primary mirror, carefully remove the mirror cell from the telescope. For the SkyView Pro 8 EQ, this means you must loosen the six screws on the side of the tube near the primary mirror. You do not need to remove the collimation screws on the bottom of the mirror cell. Remove the mirror cell from the tube. You will notice the primary mirror is held down with three clips held by two screws each. Loosen the screws and remove the clips.

You may now remove the mirror from the mirror cell. Do not touch the surface of the mirror with your fingers. Lift the mirror carefully by the edges. Set the mirror on a clean soft towel. Fill a clean sink free of abrasive cleanser, with room-temperature water, a few drops of liquid dishwashing detergent, and if possible, a capfull of 100% isopropyl alcohol. Submerge the mirror (aluminized face up) in the water and let it soak for a few minutes (or hours if it's a very dirty mirror). Wipe the mirror under water with clean cotton balls, using extremely light pressure and stroking in straight line across the mirror. Use one ball for each wipe across the mirror. Then rinse the mirror

under a stream of lukewarm water. Any particles on the surface can be swabbed gently with a series of cotton balls, each used just one time. Dry the mirror in a stream of air (a "blower bulb" works great), or remove any stray drops of water with the corner of a paper towel. Water will run off a clean surface. Cover the mirror surface with Kleenex, and leave the mirror in a warm area until it is completely dry before reassembling the telescope.

11. Specifications

Primary mirror diameter: 203mm (8")

Primary mirror coating: Aluminized, SiO₂ overcoat

Focal Length: 1000mm

Focal Ratio: f/4.9

Secondary mirror: 58mm minor axis

Secondary mirror holder: Four-vaned spider, .4mm thick vanes

Eyepieces: 25mm and 10mm Sirius Plössls, fully coated, 1.25"

Magnification: 40x (with 25mm) and 100x (with 10mm)

Finder Scope: 8x40 achromatic, 5.33° field of view

Focuser: Rack and pinion, accepts 2" or 1.25" eyepieces

Camera adapter: Couples 35mm SLR camera T-ring to focuser

Mount: SkyView Pro, German equatorial

Tripod: Steel

Tripod support tray: Aluminum, provides additional stability, holds five 1.25" eyepiece and two 2" eyepieces

Weight: 62 lbs. (Mount 30 lbs., optical tube 32 lbs.)

Counterweights: 10.9 lbs. each

Polar axis latitude adjustment: 8° to 70°

Polar axis finder: Optional

Motor Drives: Optional

One-Year Limited Warranty

This Orion SkyView Pro 8 EQ is warranted against defects in materials or workmanship for a period of one year from the date of purchase. This warranty is for the benefit of the original retail purchaser only. During this warranty period Orion Telescopes & Binoculars will repair or replace, at Orion's option, any warranted instrument that proves to be defective, provided it is returned postage paid to: Orion Warranty Repair, 89 Hangar Way, Watsonville, CA 95076. If the product is not registered, proof of purchase (such as a copy of the original invoice) is required.

This warranty does not apply if, in Orion's judgment, the instrument has been abused, mishandled, or modified, nor does it apply to normal wear and tear. This warranty gives you specific legal rights, and you may also have other rights, which vary from state to state. For further warranty service information, contact: Customer Service Department, Orion Telescopes & Binoculars, 89 Hangar Way, Watsonville, CA 95076; (800)-676-1343.

Orion Telescopes & Binoculars

89 Hangar Way, Watsonville, CA 95076

Customer Support Help Line (800)-676-1343 • Day or Evening

OrionTelescopes.com